

GAS
AUDIO POWER

MAD USER MANUAL



MAD PK1

PK1-64

MADE TO PLAY LOUD

WE PLAY LOUD!!

We know what you want. You want it LOUD, and that is exactly what we do, what we live for. Vibrations, gut-punches and straight up loud music - that's what makes us tick. We won't dress up in fancy words or claim to be something we're not. We are the NO BULLSH!T car audio brand!









Every single product with the GAS logo on it is born out of passion, the same that has driven us for two generations and that will keep us rolling up to your neighbourhood, winning and pushing the limits for many generations to come!

It's up to you to choose your own level of loud, and if you don't like what we do that's OK. You are welcome back when you've had your first true GAS experience. We don't exclude, we don't judge and we do not make up any excuses for who we are.

We are GAS and we are proud to be LOUD!

GAS

TABLE OF CONTENT

 SAFETY.....	3
 UNPACKING.....	4
 DIMENSIONS.....	4
 SPECIFICATIONS.....	6
MAD PK1-64.....	6
 FEATURES.....	7
All-in-one madness.....	7
Power of paper.....	7
For the truly crazy.....	7
Are you LOUD enough?.....	7
 HOW TO.....	8
Install component kit.....	8
Crossover function.....	9
Optional connection.....	9
Speaker & tweeter placement.....	10
 TROUBLESHOOTING.....	11
No power/sound.....	11
Unwanted noise.....	11
Distortion.....	11
 WARRANTY & DISPOSAL	12
 THE GAS WORLD.....	13



SAFETY

PLAY LOUD & SAFE. Read through this information, follow the instructions and save the manual for future usage and reference.

Make sure to pay attention to the instructions when you see this symbol: 

Do not expose the wiring to your new speaker to excessive damp or moisture. If the speaker's wiring is exposed it might result in electric failure, shock or damage to the product. Servicing is required when the product has been damaged in any way and/or doesn't operate normally. Refer all servicing to qualified service personnel only.

Keep the cables inside the vehicle separate from sharp edges or components that may be affected or take damage. Follow the recommended cable sizes and always use high quality cables and accessories. Even if you're eager to put the speakers to use – take no shortcuts when installing the cables, make sure that all connectors are protected and secured.

Do not drill any holes without checking what lies beneath, and don't cut anything without making sure that no important components risk being damaged.

There is a first time for everything, if you need help – ask a friend or contact your local GAS AUDIO POWER dealer/installer.

We want you to experience your product's MAD sound, but we don't want you to injure yourself or others. Use common sense, respect high pressure levels and volume, and follow your local laws and regulations.



UNPACKING

Unboxing your new MAD product is an experience, make sure that the speakers and all the accessories are included in the packaging:

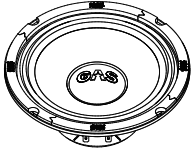

Speakers
(2pcs)



Tweeters
(2pcs)



Crossovers
(2pcs)



Manual
(1pc)

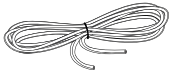

Cables
(2pcs)

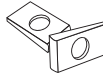

V-type clips
(14pcs)



Screws
(18pcs)

DIMENSIONS

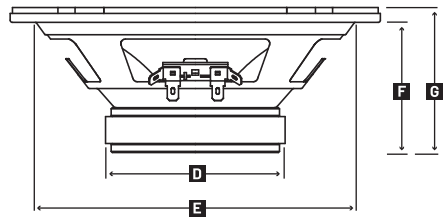
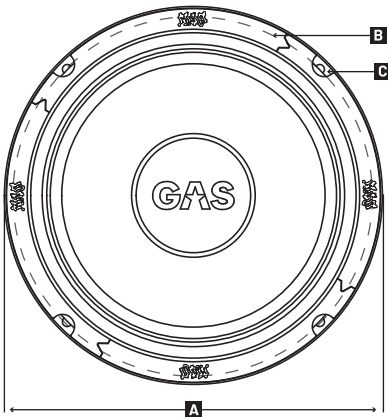

	A	B	C	D	E	F	G	
PM1-64	Ø165	Ø156	4.2	Ø80	Ø143	58	66	mm



DIMENSIONS

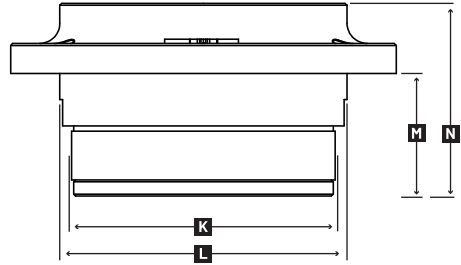
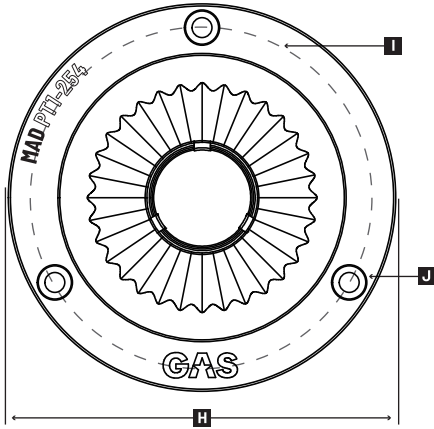

	H	I	J	K	L	M	N	
PT1-254	Ø95	Ø83	5	Ø65	Ø70	30	48	mm

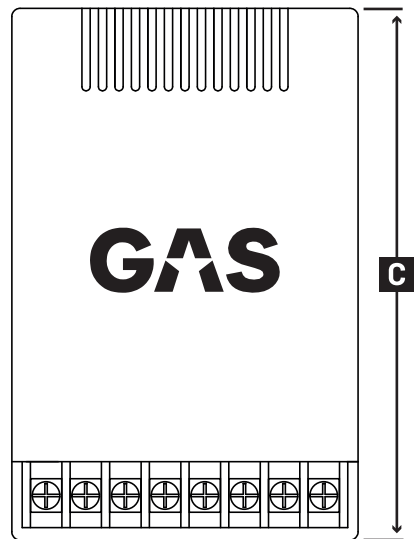
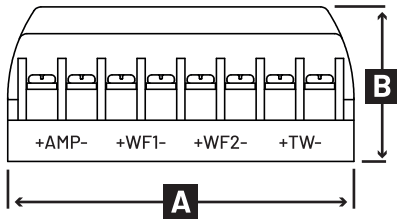

	A	B	C	
PX01-24	84	37.5	129	mm

SPECIFICATIONS

Below you'll find the specifications that has been checked and tested in our workshop. The specified sensitivity isn't directly connected with the sound pressure in the vehicle, and shouldn't be used as the sole indicator for comparison with other component kits.

MAD PK1-64

Component	Component kit
Woofers size	6.5" (165mm)
Tweeter size	1" (25mm)
Nominal impedance	4 Ohm
Power RMS	60W
Power MAX	120W
Freq. response	100-20 000Hz
Sensitivity	94dB

MAD PT1-254 TWEETER

Voice Coil	1" KSV
Tweeter cone	Black matte alu. diaphragm
Housing	Aluminum
Shorting ring	No
Tweeter magnet	HQ Ferrite
Terminal	Pre-soldered 30cm HQ cable

MAD PM1-64 WOOFER

Voice Coil	1" KSV
Woofers cone	Reinforced pressed paper
Woofers basket	Steel
Woofers suspension	2R cloth surround
Woofers magnet	HQ Ferrite
Woofers spider	Polycotton
Vas	8.65 L
Qts	1.10
Qes	1.44
Qms	7.78
Re	3.63 Ohm
Fs	112.12Hz

MAD PX01-24 CROSSOVER

Tweeter HPF	6 kHz 12dB/Oct
Woofers LPF	5 kHz 6dB/Oct
Tweeter attenuation	0 / -6 dB
Addon woofers option	Yes

FEATURES

The MAD component kit is made to be LOUD and last for years to come. We want to help you and your vehicle to be as LOUD as possible. We've made sure that is the case by using innovative and groundbreaking techniques that increase durability.

ALL-IN-ONE MADNESS

To those that are ready to play really LOUD - the PK1-64 component kit's ready for you. This all-in-one package includes two awesome PM1-64 midrange drivers, two LOUD PT1-254 horn tweeters and two matching PX01-24 crossovers. Everything you need to kick ass and take names.

POWER OF PAPER

We're referring to the pressed paper cone, of course. The MAD PM1-64 is made for playing your favorite music, as loud as possible. When testing this midrange driver, we noticed one thing: for that extra durability, the paper cone needed some extra reinforcement. Now you're ready to crank that volume knob as hard as you can. We know you want to.

FOR THE TRULY CRAZY

Look out, this combo will blow your mind. The MAD PT1 horn tweeter's here to kick some ass and show how crazy of a difference good tweeters make for a sound system. This 1-inch horn tweeter with an aluminum cone will play really LOUD and endure the toughest cruises!

ARE YOU LOUD ENOUGH?

This isn't just some random speakers and tweeters, these bad boys were made for a lifestyle, the SPL lifestyle! But beware, as soon as you have installed your first pair, you'll want to add even more speakers. And that's OK. If you're ready to take the first step into the wonderful world of SPL; just add an amplifier, hit play and make your friends jealous!



HOW TO

INSTALL COMPONENT KIT

Before installing your brand new component kit, make sure that you have everything you need. Have the right tools ready, and make sure that you have the necessary knowledge/skill to perform the installation properly. Preparation and knowledge is crucial!

The component kit includes three parts: the midrange woofers, the tweeters and the crossovers. The crossover should be wired before the midrange woofer(s) and the tweeter, it makes sure that the woofer(s) and tweeter plays on the right part of the LOUD spectrum.

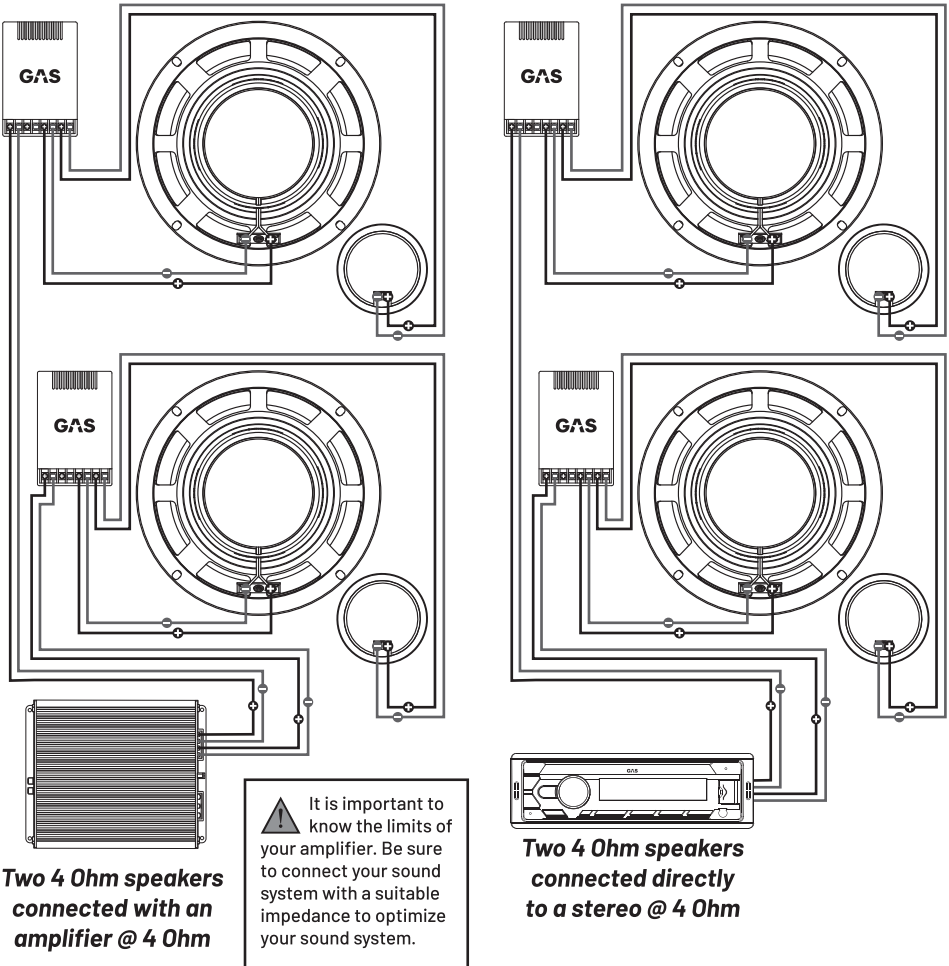

HOW TO

CROSSOVER FUNCTION

The crossover included with the PK1-64 component kit is made to give you an awesome component kit that plays LOUD! It has outputs for both the midrange woofer and the tweeter, so it is used as the bridge between the power source and the component kit. You wanna go even louder? Connect a second PM1-64 speaker to each PX01-24 crossover.

On the MAD PX01-24 crossover you can adjust the tweeter level setting between 0 or -6db to affect the tweeter attenuation. The switch is placed under the lid of the crossover. Choose the low setting for LOUD, or the high setting for LOUDER!

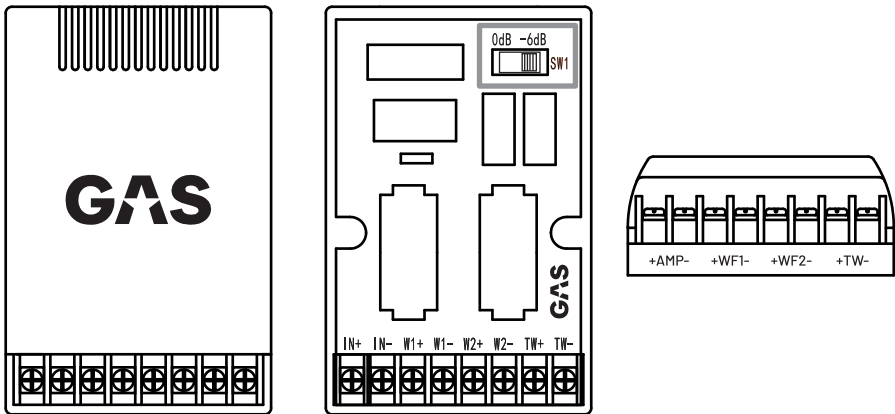

OPTIONAL CONNECTION

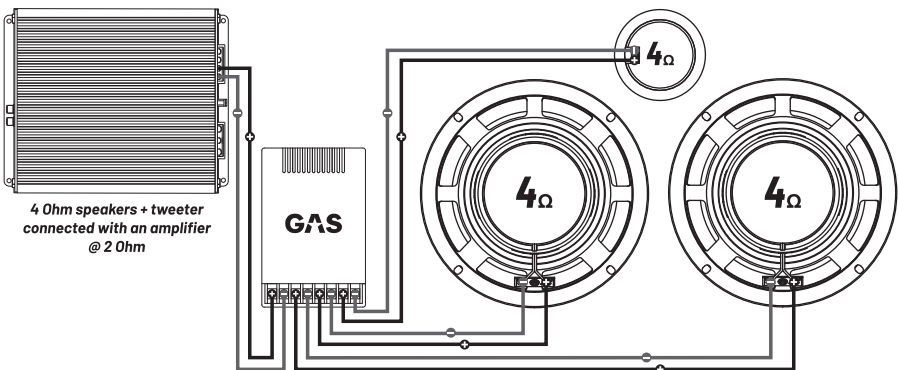

HOW TO

SPEAKER & TWEETER PLACEMENT

Now that you know how to connect your component kit, you need to decide where to put it. You will most likely have one or two possible locations to put the speakers and tweeters depending on make and model. This is where the fun begins!

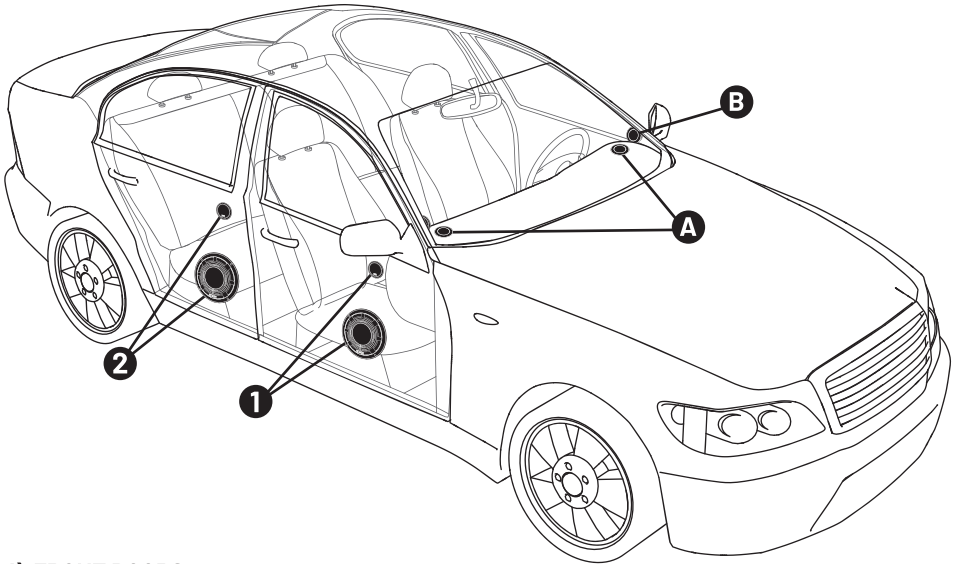

1) FRONT DOORS

The front right and left doors are typical positions for woofer placement! In some models you'll find original speakers in the kickpanel - right in front of the doors in the footwell.

2) BACK DOORS

Some car models out there have a 2-way system in the back. If your car's on the more luxurious side of the spectrum, you might find a component kit in both the front and rear.

A) DASH

The tweeter is usually placed here. Do you see a small grille around the left and right end of the dash? Awesome! Put your new tweeter here. If your car's a bit older, you might not have a tweeter in your dash. No worries! Use the ANGLED SURFACE MOUNTING and you're good.

B) A-pillar

In some cars, the tweeter is located in the A-pillar. Lucky you! This is a great location to put a tweeter, since it's placed higher up and directly aimed at your ears. Place the tweeter with the ANGLED SURFACE MOUNTING and enjoy great sound!

TROUBLESHOOTING

NO POWER/SOUND

Check the speakers to make sure they're not damaged. If your speakers don't get any power, the most common issue is either in the wiring or in the amplifier. Use a multimeter to measure the amplifier's voltage on the +12V terminal and the remote signal terminal. Use a multimeter to make sure that you have a negative ground connection. Check the built-in fuse (if there's one) on the amplifier. If there's no power coming through - control the fuse on the power cable. If it's intact - make a full check of the wiring to ensure cable integrity.

Check all the speakers connected to your sound system. Check all the speaker cables and all the signal cables. Make sure that the crossover is correct installed. Check your head unit to make sure no settings are limiting the amplifier's functions or the speakers. When all of the above has been tested/looked over, and all is as it should be but there's still no sound, consult your local GAS AUDIO POWER dealer/installer.

UNWANTED NOISE

Start by looking over the speakers in the sound system so there is no damage or connection issue with the wiring. Make sure that your signal cables or speaker cables aren't too close to the power cables. Check your amplifier's grounding point and make sure that the surface is clean. When all of the above has been tested/looked over, and the unwanted noise does not vanish, consult your local GAS AUDIO POWER dealer/installer.

DISTORTION

Start by looking over the speakers in the sound system so there's no damage or connection issue with the wiring. Check the speaker cables to make sure that the polarity isn't reversed on one channel. Check the settings on the amplifier, make sure that the gain/level is set according to the amplifier's instructions. If your amplifier has a boost function, turn it down or turn it off.



WARRANTY & DISPOSAL

This product is covered by warranty, depending on the conditions in the country where it's sold. If the speakers are returned for service, please include the original dated receipt (or a copy) with the product. Make sure that the speakers are packaged properly and secured, preferably in its original packaging.



The crossed-out wheeie bin symbol means that the product, literature and packaging included must be taken to separate collection at the end of their working life. Don't dispose of these products as unsorted municipal waste: take them for recycling. For info on your nearest recycling point, check with your local waste authority.



This product has been granted with the CE certification mark to show that the product follows the health, safety, and environmental protection standards for products sold within the European Economic Area (EEA).



GAS Audio Power products comply with the relevant provisions of the RoHS Directive for the European Union. In common with all Electrical and Electronic Equipment (EEE) the product shouldn't be disposed of as household waste. Alternative arrangements may apply in other jurisdictions.



GAS Audio Power is a global partner of the European Mobile Media Association, an organization that focus on promoting the custom made mobile media installations to consumers.

THE GAS WORLD

You've entered the world of GAS. We aim to please, and we've made sure to have products made for you. No matter what stage of the LOUD-addiction you might find yourself in, there is a GAS product to fill your need.

MAD

Just starting out? The MAD series is made to play LOUD and to be the express lane to a no bullsh!t sound system that will make sure everyone can hear you coming!

MAX

The MAX series holds products made to deserve the center stage. Powerful, heavy duty and designed to be noticed. We made NO COMPROMISES because we know that you wouldn't accept it.

CMP

The CMP series has been developed for the crucial seconds when the dB-counter starts to tick. All CMP products have hand-picked, high quality, COMPETITION GRADE components and they are specially designed to withstand an awesome amount of power.



THANKS FOR JOINING GAS AUDIO POWER!



GAS
AUDIO POWER

GAS AUDIO POWER and SHAKY are registered trademarks by Winn Scandinavia AB and is protected by relevant laws and jurisdictions such as Copyright and Trademark laws.

Winn Scandinavia AB | Elementvägen 15, 70227 Örebro, Sweden | www.winnscandinavia.com

Winn Scandinavia AB reserves for possible typos, factual or numeric errors that may have been printed on any products, package designs, user manuals and/or other included accessories.

GAS
AUDIO POWER