

**GAS**  
AUDIO POWER

**MAD** USER MANUAL



**MAD** X2

X2-34

**MADE TO PLAY LOUD**

## **WE PLAY LOUD!!**

We know what you want. You want it LOUD, and that is exactly what we do, what we live for. Vibrations, gut-punches and straight up loud music - that's what makes us tick. We won't dress up in fancy words or claim to be something we're not. We are the NO BULLSH!T car audio brand!









Every single product with the GAS logo on it is born out of passion, the same that has driven us for two generations and that will keep us rolling up to your neighbourhood, winning and pushing the limits for many generations to come!

It's up to you to choose your own level of loud, and if you don't like what we do that's OK. You are welcome back when you've had your first true GAS experience. We don't exclude, we don't judge and we do not make up any excuses for who we are.

We are GAS and we are proud to be LOUD!

# **GAS**

# TABLE OF CONTENT

 SAFETY.....	3
 UNPACKING.....	4
 DIMENSIONS.....	4
 SPECIFICATIONS.....	5
MAD X2-34.....	5
 FEATURES.....	6
A MAD speaker to fit every need.....	6
Your car was made for the X2 series.....	6
Designed to be durable.....	6
Swedish design, MAD sensibilities.....	6
 HOW TO.....	7
Install speakers.....	7
Speaker placement.....	8
 TROUBLESHOOTING.....	9
No power/sound.....	9
Unwanted noise.....	9
Distortion.....	9
 WARRANTY & DISPOSAL .....	10
 THE GAS WORLD.....	11



# SAFETY

**PLAY LOUD & SAFE.** Read through this information, follow the instructions and save the manual for future usage and reference.

Make sure to pay attention to the instructions when you see this symbol: 

Do not expose the wiring to your new speaker to excessive damp or moisture. If the speaker's wiring is exposed it might result in electric failure, shock or damage to the product. Servicing is required when the product has been damaged in any way and/or doesn't operate normally. Refer all servicing to qualified service personnel only.

Keep the cables inside the vehicle separate from sharp edges or components that may be affected or take damage. Follow the recommended cable sizes and always use high quality cables and accessories. Even if you're eager to put the speakers to use – take no shortcuts when installing the cables, make sure that all connectors are protected and secured.

Do not drill any holes without checking what lies beneath, and don't cut anything without making sure that no important components risk being damaged.

There is a first time for everything, if you need help – ask a friend or contact your local GAS AUDIO POWER dealer/installer.

We want you to experience your product's MAD sound, but we don't want you to injure yourself or others. Use common sense, respect high pressure levels and volume, and follow your local laws and regulations.



# UNPACKING

Unboxing your new MAD product is an experience, make sure that the speakers and all the accessories are included in the packaging:

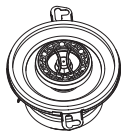

Speakers  
(2pcs)



Manual  
(1pc)



Screws  
(4pcs)



V-clips  
(4pcs)

# DIMENSIONS

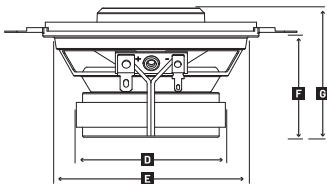
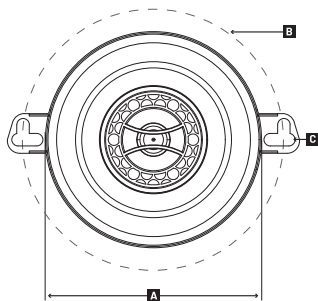

	A	B	C	D	E	F	G	
X2-34	Ø87	Ø105	12x5	Ø60	Ø78	42	52	mm

# SPECIFICATIONS

Below you'll find the specifications that has been checked and tested in our workshop. The specified sensitivity isn't directly connected with the sound pressure in the vehicle, and shouldn't be used as the sole indicator for comparison with other speakers.

## **MAD X2-34**

Component	Coaxial speaker
Woofers size	3.5" (87mm)
Tweeter size	0.51" (13mm)
Nominal impedance	4 Ohm
Power RMS	50W
Power MAX	100W
Freq. response	105-21 000Hz
Sensitivity	88dB
Woofers cone	IMPP
Woofers basket	Resonance Free Steel
Woofers suspension	NBR Rubber
Woofers magnet	Ferrite
Woofers spider	Nomex/Cotton
Tweeter dome	Silk
Tweeter magnet	Neodymium
Crossover	HP 6dB HQ (100v)

# FEATURES

The MAD coaxial speakers are made to be LOUD and last for years to come. We want to help you and your vehicle to be as LOUD as possible. We've made sure that's the case by using innovative and groundbreaking techniques that increase durability.

## A MAD SPEAKER TO FIT EVERY NEED

There's nothing better than replacing that old dusty wannabe speaker that's been hiding behind your speaker grills. Did your old speakers break 'cause they couldn't handle your level of LOUD? The X2 series is ready for you. Be proud, be loud, be MAD!

## YOUR CAR WAS MADE FOR THE X2 SERIES

Just the way you like it, just the way your car wants it - uncomplicated and made to fit like a glove. The speaker has a 13mm silk dome tweeter with NEO magnet structure and a newly developed tweeter faceplate to up your LOUD game! In boring science terms, this means you get an increased dispersion and off-axis reproduction. It also makes the speaker a perfect fit for non-ideal OEM speaker placement. The column that holds the tweeter also contains an inline crossover. This invisible placement makes the look of the speaker extra sleek.

## DESIGNED TO BE DURABLE

Our research department has truly gone MAD! For our MAD S2 subwoofers we developed a new kind of IMPP cone. We decided that this feature was so good - we brought it over to the X2 series. This means that the X2 series speakers are very durable, moist proof and ready to kick some ass!

## SWEDISH DESIGN, MAD SENSIBILITIES

The 25mm KSV voice coil is wound with lightweight CCAW (Copper Clad Aluminum Wire) that creates a dynamic sound. Since the Swedish weather encompasses all different seasons - the X2 series is designed to withstand them all. Hot, cold, UV rays - it doesn't matter. It's MAD and it's made to play LOUD, no matter the circumstances!

# HOW TO

## INSTALL SPEAKERS

Before installing your brand new speakers, make sure that you have everything you need. Have the right tools ready and make sure you have the necessary skills/knowledge to perform the installation properly. Preparation and knowledge is crucial!

The MAD X2 series uses a single 4 Ohm voice coil. If you want to connect four or more X2 series speakers, you can vary the impedance by altering the wiring configuration to use a series or parallel setup. The more the merrier!

Make sure to look through the recommended wiring schematics below and choose the setup that corresponds with the number of speakers in your sound system. Take note of the impedance stability of your amplifier. Don't be afraid to consult your local GAS AUDIO POWER dealer/installer if you have any questions.

**Two 4 Ohm speakers  
@ 4 Ohm in standard**

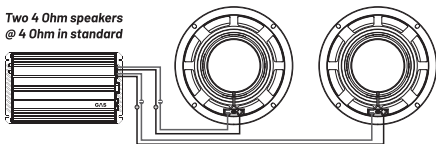

**⚠** It is important to know the limits of your amplifier. Be sure to connect your sound system with a suitable impedance to optimize your sound system.

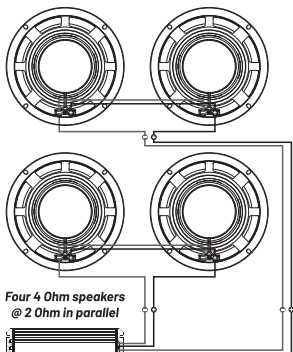

**Four 4 Ohm speakers  
@ 2 Ohm in parallel**

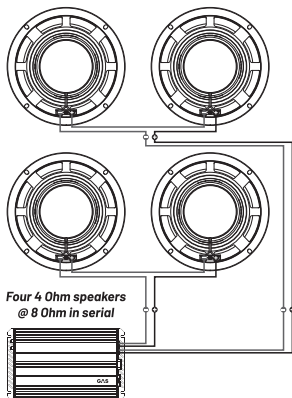

**Four 4 Ohm speakers  
@ 8 Ohm in serial**



# HOW TO

## SPEAKER PLACEMENT

Wiring tutorial - check! Now you know how to connect your cables and speakers correctly, but where do you place the speakers? You will most likely have one or two possible locations to put the speakers depending on make and model. This is where the fun begins!

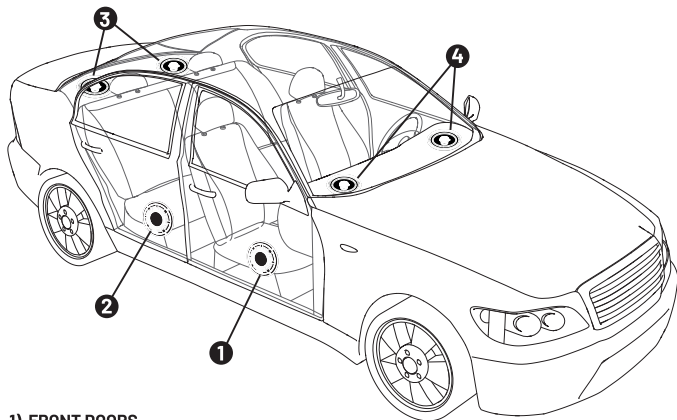

### 1) FRONT DOORS

The front right and left doors are typical speaker positions. In some models you'll find original speakers in the kickpanel - right in front of the doors in the footwell.

### 2) BACK DOORS

If your car's on the newer side of the spectrum, you might find OEM coaxial speakers here and component speakers in the front. Friends in the back seat need awesome sound too!

### 3) REAR SHELF

If you don't have speakers here, you're missing out! The rear shelf is a popular location by sound enthusiasts and some car manufacturers. If you don't have it - ADD it!

### 4) DASH

This speaker placement is found in some car models, and is normally really great for a smaller midrange, coaxial and/or tweeter speaker.

# TROUBLESHOOTING

## NO POWER/SOUND

Check the speakers to make sure they're not damaged. If your speakers don't get any power, the most common issue is either in the wiring or in the amplifier. Use a multimeter to measure the amplifier's voltage on the +12V terminal and the remote signal terminal. Use a multimeter to make sure that you have a negative ground connection. Check the built-in fuse (if there's one) on the amplifier. If there's no power coming through - control the fuse on the power cable. If it's intact - make a full check of the wiring to ensure cable integrity.

Check all the speakers connected to your sound system. Check all the speaker cables and all the signal cables. Check your head unit to make sure no settings are limiting the amplifier's functions or the speakers. When all of the above has been tested/looked over, and all is as it should be but there's still no sound, consult your local GAS AUDIO POWER dealer/installer.

## UNWANTED NOISE

Start by looking over the speakers in the sound system so there is no damage or connection issue with the wiring. Make sure that your signal cables or speaker cables aren't too close to the power cables. Check your amplifier's grounding point and make sure that the surface is clean. When all of the above has been tested/looked over, and the unwanted noise does not vanish, consult your local GAS AUDIO POWER dealer/installer.

## DISTORTION

Start by looking over the speakers in the sound system so there's no damage or connection issue with the wiring. Check the speaker cables to make sure that the polarity isn't reversed on one channel. Check the settings on the amplifier, make sure that the gain/level is set according to the amplifier's instructions. If your amplifier has a boost function, lower its effect or turn it off.



# WARRANTY & DISPOSAL

This product is covered by warranty, depending on the conditions in the country where it's sold. If the speakers are returned for service, please include the original dated receipt (or a copy) with the product. Make sure that the speakers are packaged properly and secured, preferably in its original packaging.



The crossed-out wheellie bin symbol means that the product, literature and packaging included must be taken to separate collection at the end of their working life. Don't dispose of these products as unsorted municipal waste: take them for recycling. For info on your nearest recycling point, check with your local waste authority.



This product has been granted with the CE certification mark to show that the product follows the health, safety, and environmental protection standards for products sold within the European Economic Area (EEA).



GAS Audio Power products comply with the relevant provisions of the RoHS Directive for the European Union. In common with all Electrical and Electronic Equipment (EEE) the product shouldn't be disposed of as household waste. Alternative arrangements may apply in other jurisdictions.



GAS Audio Power is a global partner of the European Mobile Media Association, an organization that focus on promoting the custom made mobile media installations to consumers.

# THE GAS WORLD

You've entered the world of GAS. We aim to please, and we've made sure to have products made for you. No matter what stage of the LOUD-addiction you might find yourself in, there is a GAS product to fill your need.

## **MAD**

Just starting out? The MAD series is made to play LOUD and to be the express lane to a no bullsh!t sound system that will make sure everyone can hear you coming!

## **MAX**

The MAX series holds products made to deserve the center stage. Powerful, heavy duty and designed to be noticed. We made NO COMPROMISES because we know that you wouldn't accept it.

## **CMP**

The CMP series has been developed for the crucial seconds when the dB-counter starts to tick. All CMP products have hand-picked, high quality, COMPETITION GRADE components and they are specially designed to withstand an awesome amount of power.



# THANKS FOR JOINING GAS AUDIO POWER!



**GAS**  
**AUDIO POWER**

GAS AUDIO POWER and SHAKY are registered trademarks by Winn Scandinavia AB and is protected by relevant laws and jurisdictions such as Copyright and Trademark laws.

Winn Scandinavia AB | Elementvägen 15, 70227 Örebro, Sweden | [www.winnscandinavia.com](http://www.winnscandinavia.com)

Winn Scandinavia AB reserves for possible typos, factual or numeric errors that may have been printed on any products, package designs, user manuals and/or other included accessories.





**GAS**  
AUDIO POWER